

Data Sheet



Article number: 021816011172

Description: Clamp with bracket and rubber
SPGU 6011. 172/30 SK

Measures

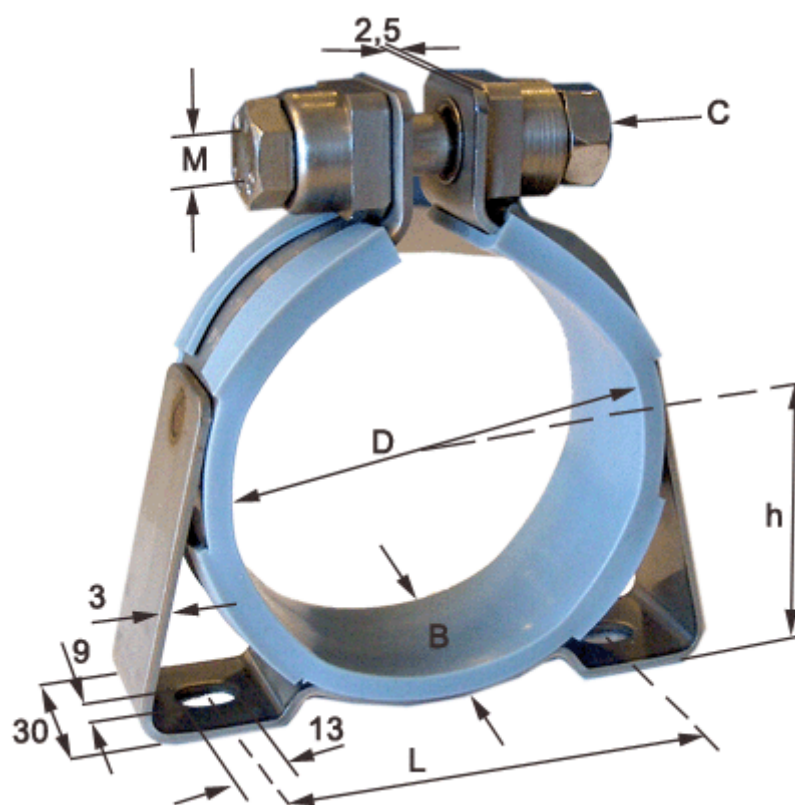

C (screw type) = SK hexagon screw

Diameter D = 172

h = 95

L = 148

Width B = 30